

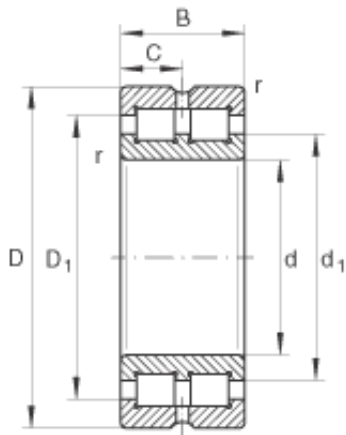

NTK BEARING CORP. OF CANADA LTD.



70 mm x 100 mm x 30 mm INA SL014914 Cylindrical Roller Bearings

Bearing No. SL014914

SL014914 Bearing 2D drawings and 3D CAD models

Size	70x100x30 mm
Bore Diameter	70 mm
Outer Diameter	100 mm
Width	30 mm
d	70 mm
D	100 mm
B	30 mm
C	15 mm
D ₁	87,4 mm
d ₁	82,5 mm
r _{min}	1 mm
	NNC4914V / Designation to DIN 5412
m	0,78 kg / Weight
C _r	106000 N / Dynamic load rating (radial)
C _{0r}	185000 N / Static load rating (radial)
C _{ur}	27000 N / Fatigue limit load, radial
n _G	3900 1/min / Limiting speed
Category	Cylindrical Roller Bearings
Inventory	0.0
Manufacturer Name	SCHAEFFLER GROUP
Minimum Buy Quantity	N/A
Weight / Kilogram	0.94



NTK BEARING CORP. OF CANADA LTD.

EAN	4012802368352
Product Group	B04144
Bore Profile	Straight
Cage Material	None
Precision Class	RBEC 1 ISO P0
Number of Rows of Rollers	Double Row
Separable	No
Rolling Element	Cylindrical Roller Bearing
Profile	Complete with Outer and Inner Ring
Snap Ring	No
Internal Clearance	C0-Medium
Retainer	No
Relubricatable	Yes
Inch - Metric	Metric
Other Features	Full Complement 3 Rib Inner Ring 2 Rib Outer Ring Operating Temperature From -30 to 120 Deg
Long Description	70MM Bore; Straight Bore Profile; 100MM Outside Diameter; 30MM Width; RBEC 1 ISO P0; Double Row; Not Separable; No Snap Ring; Relubricatable; C0-Medium Internal Clearance; No Retainer
Category	Cylindrical Roller Bearing
UNSPSC	31171547
Harmonized Tariff Code	8482.50.00.00
Noun	Bearing
Manufacturer URL	http://www.ina.com
Manufacturer Item Number	SL014914
Weight / LBS	2.059
Width	1.181 Inch 30 Millimeter



NTK BEARING CORP. OF CANADA LTD.

Outside Diameter	3.937 Inch 100 Millimeter
Bore	2.756 Inch 70 Millimeter